













**WORKSHOP FURNITURE**

- p. 319  Modular furnishings
- p. 327  Workbenches
- p. 329  Cabinets
- p. 333  Tool rolling cabinets
- p. 337  Tool boxes



**BENCH VICES, CLAMPS AND ANVILS**

- p. 342  Bench vices
- p. 344  Vices
- p. 345  Anvils





**MACHINERY FOR FINISHING**

- p. 348  Sandblast cabinets
- p. 355  Cleaning tanks
- p. 358  Vacuum cleaners wet and dry
- p. 361  Marking



**PRESSES AND HYDRAULIC PUMPS**

- p. 365  Hydraulic presses
- p. 367  Manual presses
- p. 368  Hydraulic pump units









**CAR AND MOTORCYCLE WORKSHOP**

- p. 370  Trolley jacks and stands
- p. 372  Hydraulic cranes and engine stands
- p. 374  Oil collecting units
- p. 375  Winches
- p. 376  Motorcycle and quad lifts
- p. 378  Trolleys



**LIFTING AND HANDLING**

- p. 379  Hydraulic jacks
- p. 380  Trolleys
- p. 383  Cable hoists
- p. 384  Lifting accessories
- p. 387  Winches and tensioners
- p. 388  Pallet handling



## THE OPTIMAL SOLUTION TO FURNISH YOUR WORKSHOP, YOUR GARAGE OR YOUR RACING CORNER

CHOOSE FROM THE COMPOSITIONS CREATED FOR YOU BY FERVI OR CONFIGURE YOUR MODULAR AND SELF-SUPPORTING WORKSHOP FURNITURE ACCORDING TO YOUR NEEDS

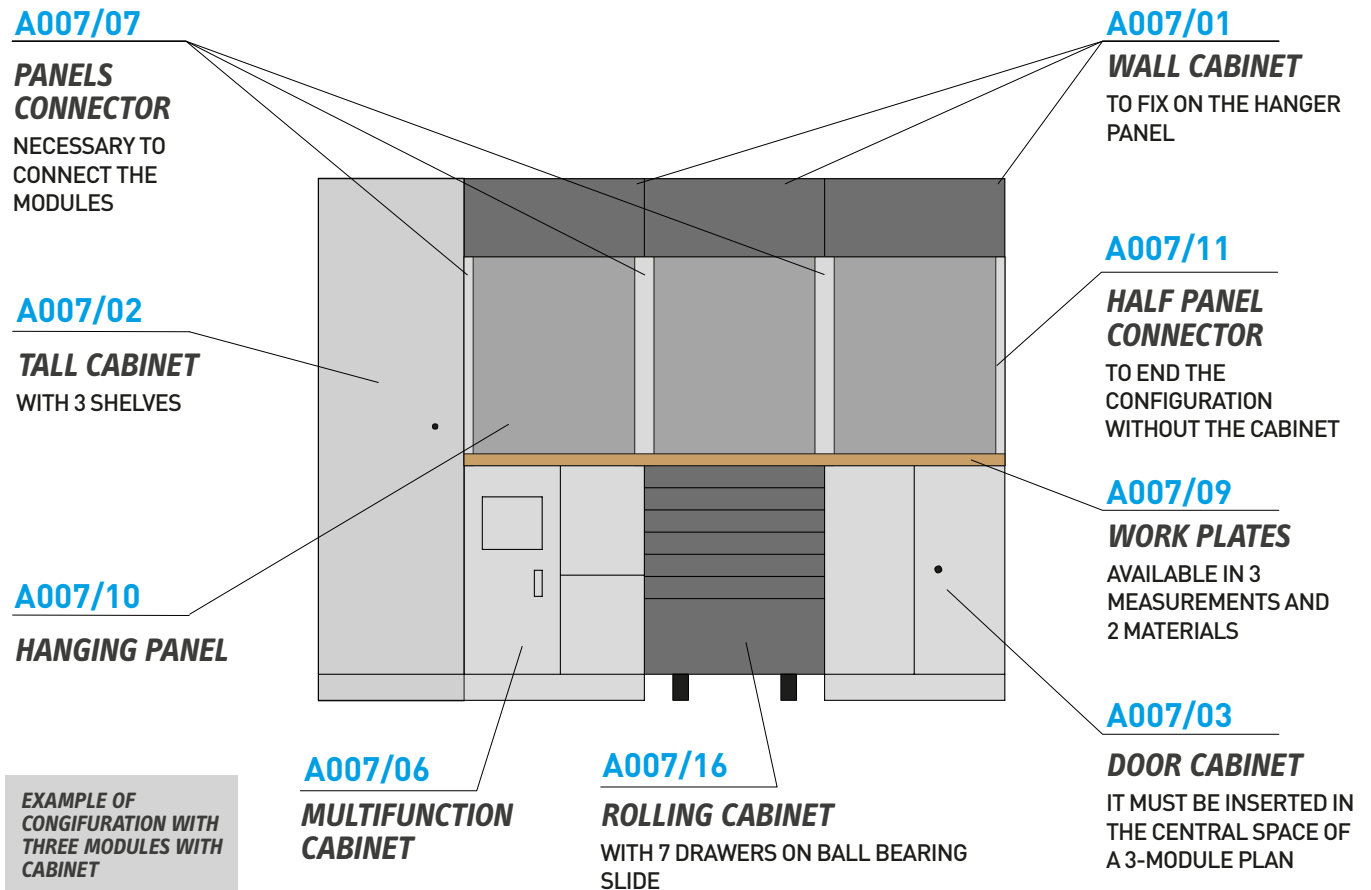

EXAMPLE OF CONFIGURATION WITH THREE MODULES WITH CABINET

**A007A**

**WORKSHOP MODULAR FURNITURES**

The optimal solution to furnish your workshop, your garage or your racing corner.

- 4 WALL CABINET WITH SPRING GAS [A007/01]
- 2 TALL CABINETS WITH 3 SHELVES [A007/02]
- 1 DOOR CABINET WITH ONE SHELF [A007/03]
- 1 TOOL CABINET WITH 4 DRAWERS ON BALL BEARING SLIDE [A007/04]
- 2 TOOL CABINETS WITH 5 DRAWERS ON BALL BEARING SLIDES [A007/05]
- 5 PANELS CONNECTORS [A007/07]
- 2 WOOD PLATES [A007/08]
- 4 HANGING PANELS [A007/10]

Dimensions 3920 x 498 x 2000h mm



**A007B**

**WORKSHOP MODULAR FURNITURES**

The optimal solution to furnish your workshop, your garage or your racing corner.

- 4 WALL CABINET WITH SPRING GAS [A007/01]
- 2 TALL CABINETS WITH 3 SHELVES [A007/02]
- 1 DOOR CABINET WITH ONE SHELF [A007/03]
- 2 TOOL CABINETS WITH 5 DRAWERS ON BALL BEARING SLIDES [A007/05]
- 1 MULTIFUNCTION CABINET [A007/06]
- 5 PANELS CONNECTORS [A007/07]
- 2 WOOD PLATES [A007/08]
- 4 HANGING PANELS [A007/10]

Dimensions 3920 x 498 x 2000h mm



**A007C**

**WORKSHOP MODULAR FURNITURES**

The optimal solution to furnish your workshop, your garage or your racing corner.

- 2 WALL CABINET WITH SPRING GAS [A007/01]
- 1 TALL CABINET WITH 3 SHELVES [A007/02]
- 1 DOOR CABINET WITH ONE SHELF [A007/03]
- 1 TOOL CABINETS WITH 5 DRAWERS ON BALL BEARING SLIDES [A007/05]
- 2 HANGING PANELS [A007/10] 2
- PANELS CONNECTORS [A007/07]
- 1 WOOD PLATE [A007/08]
- 2 HANGING PANELS [A007/10]
- 1 HALF PANEL CONNECTOR [A007/11]

Dimensions 1960 x 498 x 2000h mm

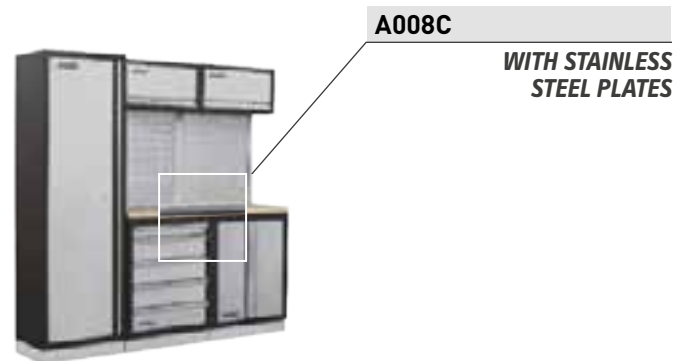

**A007D**

**WORKSHOP MODULAR FURNITURES**

The optimal solution to furnish your workshop, your garage or your racing corner.

- 3 WALL CABINET WITH SPRING GAS [A007/01]
- 1 TALL CABINET WITH 3 SHELVES [A007/02]
- 1 DOOR CABINET WITH ONE SHELF [A007/03]
- 1 TOOL CABINET WITH 4 DRAWERS ON BALL BEARING SLIDE [A007/04]
- 1 TOOL CABINETS WITH 5 DRAWERS ON BALL BEARING SLIDES [A007/05]
- 3 PANELS CONNECTORS [A007/07]
- 1 WOOD PLATE [A007/09]
- 3 HANGING PANELS [A007/10]
- 1 HALF PANEL CONNECTOR [A007/11]

Dimensions 2640 x 498 x 2000h mm

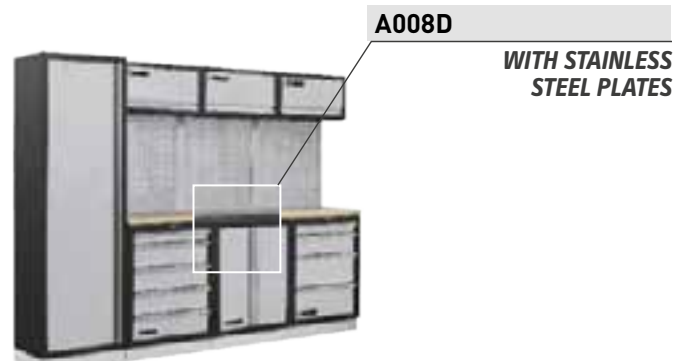



**A007E**
**WORKSHOP MODULAR FURNITURES**

The optimal solution to furnish your workshop, your garage or your racing corner.

- 3 WALL CABINET WITH SPRING GAS [A007/01]
- 1 TALL CABINET WITH 3 SHELVES [A007/02]
- 1 DOOR CABINET WITH ONE SHELF [A007/03]
- 1 MULTIFUNCTION CABINET [A007/06]
- 3 PANELS CONNECTORS [A007/07]
- 1 WOOD PLATE [A007/09]
- 3 HANGING PANELS [A007/10]
- 1 ROLLING CABINET WITH 7 DRAWERS ON BALL BEARING SLIDE [A007/16]

Dimensions 2640 x 498 x 2000h mm

**A008E**
**WITH STAINLESS STEEL PLATES**
**A007F**
**CORNER FOR WORKSHOP MODULAR FURNITURES**

The optimal solution to furnish your workshop, your garage or your racing corner.

- 2 PANELS CONNECTORS [A007/07]
- 2 HALF PANEL CONNECTORS [A007/11]
- 2 CORNER HANGING PANELS [A007/12]
- 1 CORNER CABINET [A007/13]
- 1 CORNER WOOD PLATE [A007/14]
- 1 CORNER DOOR CABINET [A007/15]

Dimensions 864 x 864 x 2000h mm

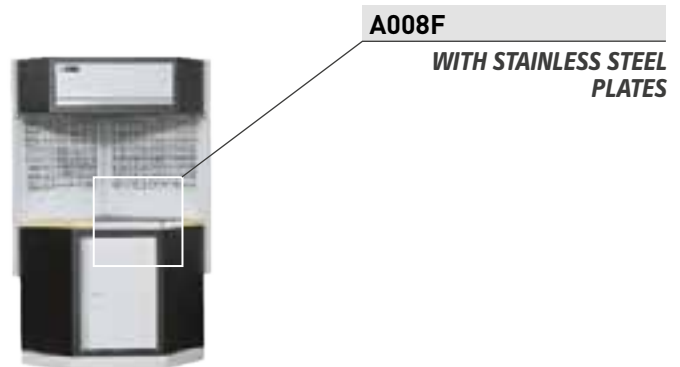
**A008F**
**WITH STAINLESS STEEL PLATES**
**A007G**
**WORKSHOP MODULAR FURNITURES**

The optimal solution to furnish your workshop, your garage or your racing corner.

- 3 WALL CABINET WITH SPRING GAS [A007/01]
- 1 TALL CABINET WITH 3 SHELVES [A007/02]
- 1 DOOR CABINET WITH ONE SHELF [A007/03]
- 1 MULTIFUNCTION CABINET [A007/06]
- 3 PANELS CONNECTORS [A007/07]
- 1 WOOD PLATE [A007/09]
- 3 HANGING PANELS [A007/10]
- 1 HALF PANEL CONNECTOR [A007/11]
- 1 TOOL CABINETS WITH 7 DRAWERS ON BALL BEARING SLIDES [A007/1]

Dimensions 2640 x 498 x 2000h mm

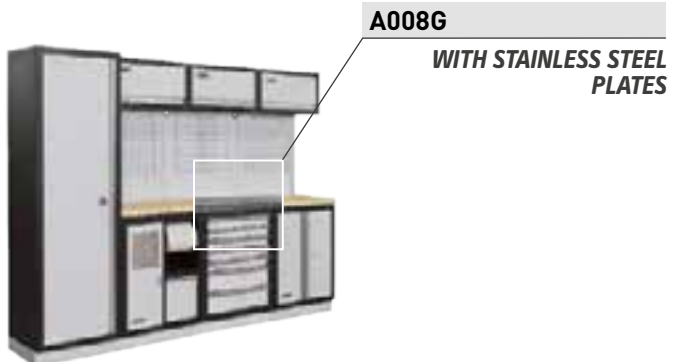
**A008G**
**WITH STAINLESS STEEL PLATES**
**A007H**
**WORKSHOP MODULAR FURNITURES**

The optimal solution to furnish your workshop, your garage or your racing corner.

- 5 WALL CABINET WITH SPRING GAS [A007/01]
- 1 TALL CABINETS WITH 3 SHELVES [A007/02]
- 1 DOOR CABINET WITH ONE SHELF [A007/03]
- 1 TOOL CABINET WITH 4 DRAWERS ON BALL BEARING SLIDE [A007/04]
- 1 TOOL CABINET WITH 5 DRAWERS ON BALL BEARING SLIDE [A007/05]
- 1 MULTI FUNCTION CABINET [A007/06]
- 6 PANELS CONNECTORS [A007/07]
- 1 WOOD PLATE [A007/08]
- 1 WOOD PLATE [A007/09]
- 5 HANGING PANELS [A007/10]
- 3 HALF PANEL CONNECTORS [A007/11]
- 2 CORNER HANGING PANELS [A007/12]
- 1 CORNER CABINET [A007/13]
- 1 CORNER WOOD PLATE [A007/14]
- 1 CORNER DOOR CABINET [A007/15]
- 1 ROLLING CABINET WITH 7 DRAWERS ON BALL BEARING SLIDE [A007/16]

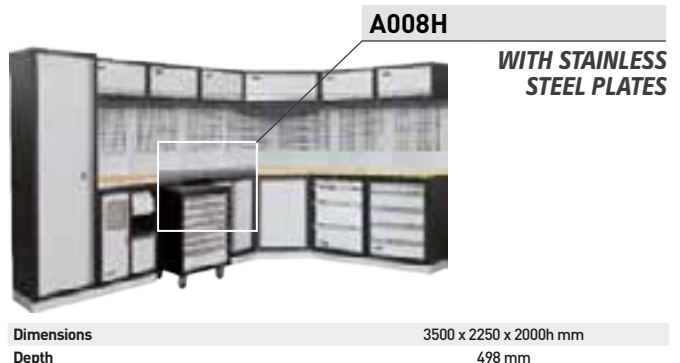
**A008H**
**WITH STAINLESS STEEL PLATES**

Dimensions 3500 x 2250 x 2000h mm  
Depth 498 mm



**A007I**

**WORKSHOP MODULAR FURNITURES**

The optimal solution to furnish your workshop, your garage or your racing corner.

- 2 WALL CABINET WITH SPRING GAS [A007/01]
- 1 TALL CABINETS WITH 3 SHELVES [A007/02]
- 1 MULTI FUNCTION CABINET [A007/06]
- 2 PANELS CONNECTORS [A007/07]
- 1 WOOD PLATE [A007/08]
- 2 HANGING PANELS [A007/10]
- 1 HALF PANEL CONNECTOR [A007/11]
- 1 TOOL CABINET WITH 7 DRAWERS ON BALL BEARING SLIDE [A007/17]

Dimensions 1960 x 498 x 2000h mm



**A007L**

**WORKSHOP MODULAR FURNITURES**

The optimal solution to furnish your workshop, your garage or your racing corner.

- 4 WALL CABINET WITH SPRING GAS [A007/01]
- 2 TALL CABINETS WITH 3 SHELVES [A007/02]
- 1 DOOR CABINET WITH ONE SHELF [A007/03]
- 1 TOOL CABINET WITH 4 DRAWERS ON BALL BEARING SLIDE [A007/04]
- 1 MULTI FUNCTION CABINET [A007/06]
- 6 PANELS CONNECTORS [A007/07]
- 2 WOOD PLATES [A007/08]
- 4 HANGING PANELS [A007/10]
- 2 HALF PANEL CONNECTORS [A007/11]
- 2 CORNER HANGING PANELS [A007/12]
- 1 CORNER CABINET [A007/13]
- 1 CORNER WOOD PLATE [A007/14]
- 1 CORNER DOOR CABINET [A007/15]
- 1 TOOL CABINET WITH 7 DRAWERS ON BALL BEARING SLIDE [A007/17]

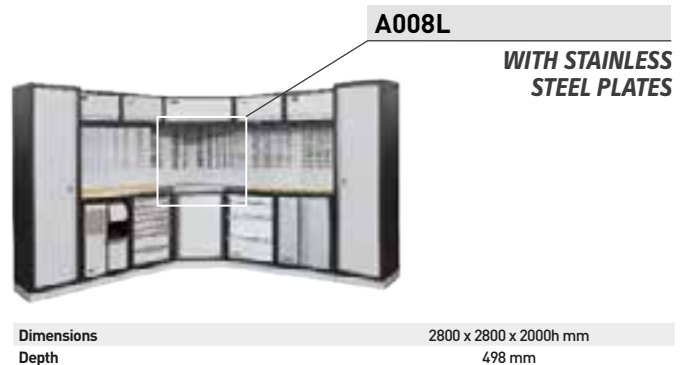

**A007M**

**WORKSHOP MODULAR FURNITURES**

The optimal solution to furnish your workshop, your garage or your racing corner.

- 2 WALL CABINET WITH SPRING GAS [A007/01]
- 1 DOOR CABINET WITH ONE SHELF [A007/03]
- 1 TOOL CABINET WITH 5 DRAWERS ON BALL BEARING SLIDE [A007/05]
- 2 PANELS CONNECTORS [A007/07]
- 1 WOOD PLATE [A007/08]
- 2 HANGING PANELS [A007/10]
- 2 HALF PANEL CONNECTORS [A007/11]

Dimensions 1360 x 498 x 2000h mm

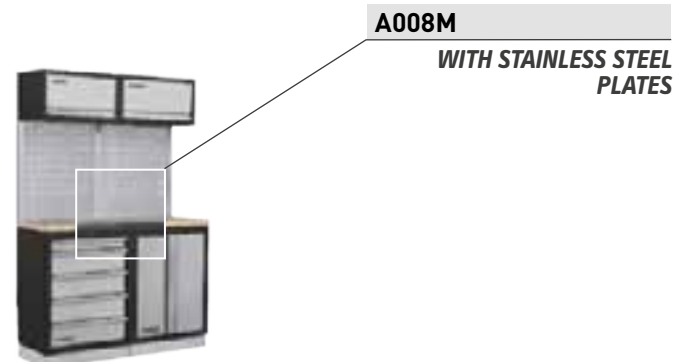

**A007N**

**WORKSHOP MODULAR FURNITURES**

The optimal solution to furnish your workshop, your garage or your racing corner.

- 3 WALL CABINET WITH SPRING GAS [A007/01]
- 1 DOOR CABINET WITH ONE SHELF [A007/03]
- 1 TOOL CABINET WITH 4 DRAWERS ON BALL BEARING SLIDE [A007/04]
- 1 TOOL CABINET WITH 5 DRAWERS ON BALL BEARING SLIDE [A007/05]
- 3 PANELS CONNECTORS [A007/07]
- 1 WOOD PLATE [A007/09]
- 3 HANGING PANELS [A007/10]
- 2 HALF PANEL CONNECTORS [A007/11]

Dimensions 2040 x 498 x 2000h mm



**A007P**
**WORKSHOP MODULAR FURNITURES**

The optimal solution to furnish your workshop, your garage or your racing corner.

- 4 WALL CABINET WITH SPRING GAS [A007/01]
- 2 TALL CABINETS WITH 3 SHELVES [A007/02]
- 1 DOOR CABINET WITH ONE SHELF [A007/03]
- 1 MULTIFUNCTION CABINET [A007/06]
- 5 PANELS CONNECTORS [A007/07]
- 1 WOOD PLATE [A007/09]
- 4 HANGING PANELS [A007/10]
- 1 TOOL CABINET WITH 7 DRAWERS ON BALL BEARING SLIDES [A007/16]
- 1 WOOD PLATE [A007/19]
- 1 TOOL CABINET WITH 9 DRAWERS ON BALL BEARING SLIDES [A007/20]

Dimensions 3920 x 498 x 2000h mm

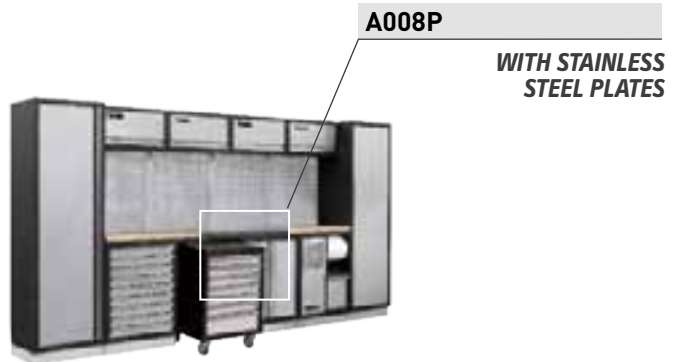
**A007Q**
**WORKSHOP MODULAR FURNITURES**

The optimal solution to furnish your workshop, your garage or your racing corner.

- 2 WALL CABINET WITH SPRING GAS [A007/01]
- 1 TALL CABINET WITH 3 SHELVES [A007/02]
- 1 TOOL CABINET WITH 4 DRAWERS ON BALL BEARING SLIDE [A007/04]
- 2 PANELS CONNECTORS [A007/07]
- 1 WOOD PLATE [A007/08]
- 2 HANGING PANELS [A007/10]
- 1 HALF PANEL CONNECTOR [A007/11]
- 1 TOOL CABINET WITH 9 DRAWERS ON BALL BEARING SLIDE [A007/20]

Dimensions 1960 x 498 x 2000h mm

**A007R**
**WORKSHOP MODULAR FURNITURES**

The optimal solution to furnish your workshop, your garage or your racing corner.

- 1 WALL CABINET WITH SPRING GAS [A007/01]
- 2 PANELS CONNECTORS [A007/07]
- 1 HANGING PANEL [A007/10]
- 2 HALF PANEL CONNECTORS [A007/11]
- 1 WOOD PLATE [A007/19]
- 1 TOOL CABINET WITH 9 DRAWERS ON BALL BEARING SLIDE [A007/20]

Dimensions 680 x 498 x 2000h mm

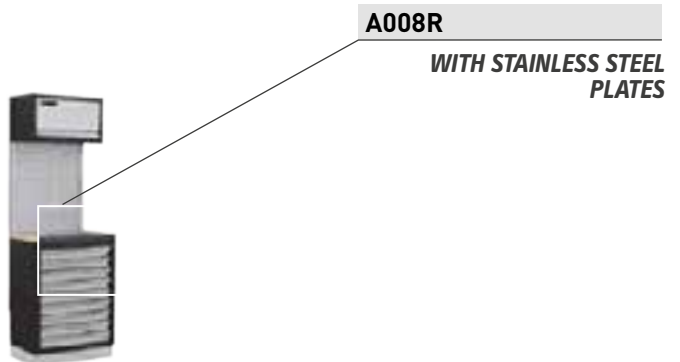
**A007S**
**WORKSHOP MODULAR FURNITURES**

The optimal solution to furnish your workshop, your garage or your racing corner.

- 3 WALL CABINET WITH SPRING GAS [A007/01]
- 1 TALL CABINET WITH 3 SHELVES [A007/02]
- 1 DOOR CABINET WITH ONE SHELF [A007/03]
- 3 PANELS CONNECTORS [A007/07]
- 1 WOOD PLATE [A007/09]
- 3 HANGING PANELS [A007/10]
- 1 HALF PANEL CONNECTOR [A007/11]
- 1 TOOL CABINETS WITH 9 DRAWERS ON BALL BEARING SLIDES [A007/20]
- 1 TROLLEY WITH 3 SHELVES [A007/22]

Dimensions 2640 x 498 x 2000h mm



**A007T**

**WORKSHOP MODULAR FURNITURES**

The optimal solution to furnish your workshop, your garage or your racing corner.

- 2 WALL CABINET WITH SPRING GAS [A007/01]
- 1 DOOR CABINET WITH ONE SHELF [A007/03]
- 1 TOOL CABINETS WITH 5 DRAWERS ON BALL BEARING SLIDES [A007/05]
- 2 PANELS CONNECTORS [A007/07]
- 1 WOOD PLATE [A007/08]
- 2 HANGING PANELS [A007/10]
- 1 HALF PANEL CONNECTOR [A007/11]
- 1 2 DOOR TALL CABINET WITH 3 SHELVES [A007/23]

Dimensions 2275 x 498 x 2000h mm



**A007U**

**WORKSHOP MODULAR FURNITURES**

The optimal solution to furnish your workshop, your garage or your racing corner.

- 3 WALL CABINET WITH SPRING GAS [A007/01]
- 1 TALL CABINET WITH 3 SHELVES [A007/02]
- 1 DOOR CABINET WITH ONE SHELF [A007/03]
- 3 PANELS CONNECTORS [A007/07]
- 1 WOOD PLATE [A007/09]
- 3 HANGING PANELS [A007/10]
- 1 HALF PANEL CONNECTOR [A007/11]
- 1 TOOL CABINET WITH 7 DRAWERS ON BALL BEARING SLIDES [A007/17]
- 1 HOSE REELS CABINET [A007/18]

Dimensions 2640 x 498 x 2000h mm

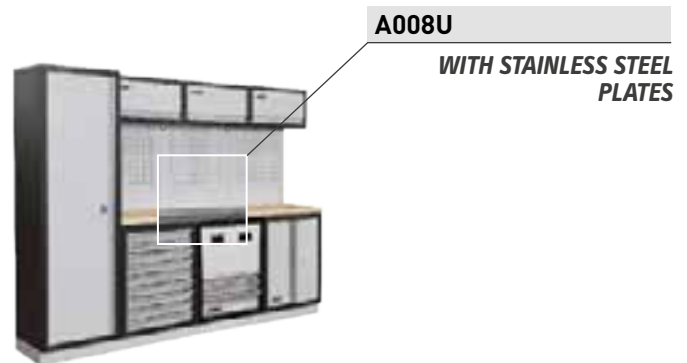

**A007UF**

**WORKSHOP MODULAR FURNITURES**

The optimal solution to furnish your workshop, your garage or your racing corner.

- 3 WALL CABINET WITH SPRING GAS [A007/01]
- 1 TALL CABINET WITH 3 SHELVES [A007/02]
- 1 DOOR CABINET WITH ONE SHELF [A007/03]
- 3 PANELS CONNECTORS [A007/07]
- 1 WOOD PLATE [A007/09]
- 3 HANGING PANELS [A007/10]
- 1 HALF PANEL CONNECTOR [A007/11]
- 1 TOOL CABINET WITH 7 DRAWERS ON BALL BEARING SLIDES [A007/17]
- 1 HOSE REELS CABINET [A007/18]
- 1 AUTO RE-ENTERING CABLE REEL [0621/A3]
- 1 AUTO REWIND AIR HOSE REEL [0481/15]

Dimensions 2640 x 498 x 2000h mm

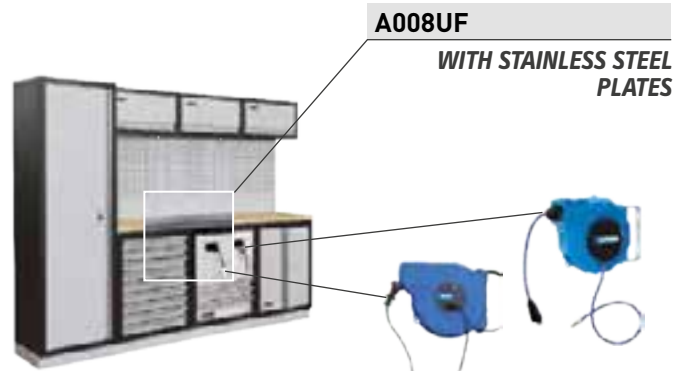

**A007V**

**WORKSHOP MODULAR FURNITURES**

The optimal solution to furnish your workshop, your garage or your racing corner.

- 4 WALL CABINET WITH SPRING GAS [A007/01]
- 2 TALL CABINETS WITH 3 SHELVES [A007/02]
- 1 TOOL CABINET WITH 5 DRAWERS ON BALL BEARING SLIDES [A007/05]
- 1 MULTIFUNCTION CABINET [A007/06]
- 5 PANELS CONNECTORS [A007/07]
- 1 WOOD PLATE [A007/08]
- 4 HANGING PANELS [A007/10]
- 1 LARGE AMERICAN TOOL CABINET [A007/21]

Dimensions 3920 x 498 x 2000h mm

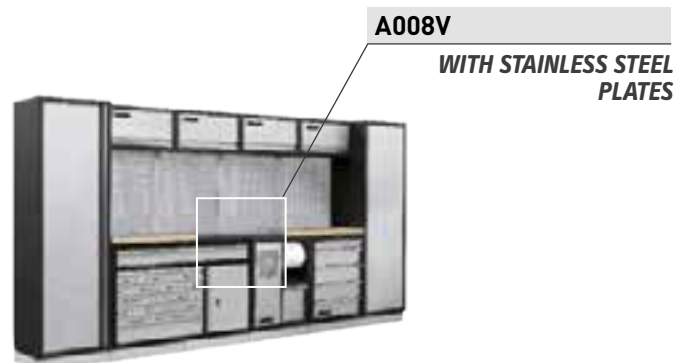



**A007/02**
**TALL CABINET**

With 3 shelves.



Dimensions	600 x 458 x 2000 mm
Door dimensions	510 x 1810 mm
Internal depth	410 mm
Maximum capacity	180 kg

**A007/23**
**2 DOOR TALL CABINET**

With 5 shelves.



Dimensions	915 x 458 x 2000 mm
Door dimensions	510 x 1810 mm
Internal depth	410 mm
Maximum capacity	300 kg

**A007/03**
**DOOR CABINET**

With one shelf.



Dimensions	680 x 458 x 910 mm
Door dimensions	710 x 295 mm
Internal depth	445 mm
Maximum capacity	60 kg

**A007/06**
**MULTIFUNCTION CABINET**

Dimensions	680 x 458 x 910 mm
Door dimensions	710 x 295 mm
Internal depth	445 mm
Drawer dimensions	240 x 300 mm
Maximum paper roll height	240 mm
Maximum capacity	90 kg

**A007/18**
**HOSE REELS CABINET**

Dimensions	680 x 458 x 910 mm
Drawer capacity	30 kg

**A007/04**
**TOOL CABINET WITH 4 DRAWERS**

On ball bearing slide.



Dimensions	680 x 458 x 910 mm
Drawer dimensions	550 x 400 mm
Drawers height	1 x 68 mm - 1 x 145 mm - 2 x 214 mm
Drawer capacity	30 kg

**A007/05**
**TOOL CABINET WITH 5 DRAWERS**

On ball bearing slide.



Dimensions	680 x 458 x 910 mm
Drawer dimensions	550 x 400 mm
Drawers height	1 x 68 mm - 4 x 145 mm
Drawer capacity	30 kg

**A007/17**
**TOOL CABINET WITH 7 DRAWERS**

On ball bearing slide.



Dimensions	680 x 458 x 910 mm
Drawer dimensions	550 x 400 mm
Drawers height	5 x 74.5 mm - 2 x 153.5 mm
Drawer capacity	30 kg



**A007/20**

**TOOL CABINET WITH 9 DRAWERS**

On ball bearing slide.



Dimensions	680 x 458 x 910 mm
Drawer dimensions	550 x 400 mm
Drawers height	9 x 74,5 mm
Drawer capacity	30 kg

**A007/16**

**ROLLING CABINET**

With 7 drawers on ball bearing slide.



Dimensions	660 x 455 x 860 mm
Drawer dimensions	525 x 400 mm
Internal depth	6 x 68 mm - 1 x 145 mm
Drawer capacity	30 kg

**A007/211**

**LARGE AMERICAN TOOL CABINET**

With stainless steel top.



Dimensions	1360 x 458 x 948,5 mm
Door dimensions	535 x 430 mm
Drawer dimensions	1 - 1285 x 400 mm   6 - 810 x 400 mm
Drawers height	1 x 123,5 mm - 5 x 74,5 mm - 1 x 153,5 mm
Drawer capacity	30 kg

**A007/10**

**HANGING PANEL**



Dimensions	1052 x 614,5 x 24 mm
Maximum capacity	10 kg

**A007/22**

**TROLLEY**

With 3 shelves.



Dimensions	648 x 458 x 865 mm
------------	--------------------

**A007/21**

**LARGE AMERICAN TOOL CABINET**

With wooden top.



Dimensions	1360 x 458 x 945 mm
Door dimensions	535 x 430 mm
Drawer dimensions	1 - 1285 x 400 mm   6 - 810 x 400 mm
Drawers height	1 x 123,5 mm - 5 x 74,5 mm - 1 x 153,5 mm
Drawer capacity	30 kg

**A007/01**

**WALL CABINET**

With spring gas.



Dimensions	680 x 281 x 350 mm
Door dimensions	610 x 280 mm
Internal depth	280 mm
Maximum capacity	15 kg

**A007/07**

**PANELS CONNECTOR**



**A007/11**

**HALF PANEL CONNECTOR**



**A007-xP**
**WORK PLATES**

Art.	Module	Material	Dimensions	Thickness
A007/08	2	Wood	1360 x 460 mm	35 mm
A007/08I	2	Stainless steel	1360 x 460 mm	35 mm
A007/09	3	Wood	2040 x 460 mm	35 mm
A007/09I	3	Stainless steel	2040 x 460 mm	35 mm
A007/19	1	Wood	680 x 460 mm	35 mm
A007/19I	1	Stainless steel	680 x 460 mm	35 mm

**A007/LED**
**LED LIGHT FOR WORKSHOP MODULAR FURNITURES**

With bi-adhesive tape, to be used in coupling with A007/Led/C charger. Two Led strips can be connected in series.



Box

**A007/LED/C**
**LED LIGHT POWER SUPPLY**

Box

**P40VD**
**FOOTBOARDS**

Mountable, green draining self locking footboard.



Polyprop.

**Dimensions** 400 x 400 x 48 mm

**Pcs. - Pallet** 120 = 20 m<sup>2</sup>
**PSV-F**
**POLYPROPYLENE SLIDE**

Mountable for footboards, green, female (without hooks).



Polyprop.

**Dimensions** 205 x 400 x 48 mm

**PSV-M**
**POLYPROPYLENE SLIDE**

Mountable for footboards, green, male (with hooks).



Polyprop.

**Dimensions** 205 x 400 x 48 mm

**PAV**
**CORNER SLIDES**

For mountable polypropylene footboards, kit of 4 green corner slides.



4 Pcs

Polyprop.

**Dimensions** 200 x 200 x 270 x 48 mm



**B015**

**STEEL WORKBENCH KIT**

With steel top and two lockable drawers.



**UPGRADE**

Bench dimensions	1500 x 645 x 865h mm
Legs thickness	1 mm
Plate thickness	2 mm
Capacity	800 kg
Drawer dimensions	433 x 347 x 122h mm
Drawer capacity	30 kg
Net weight	62 kg

**B015/10**

**WORKBENCH KIT**

With steel top and lockable drawer.



**UPGRADE**

Dimensions	1000 x 640 x 865h mm
Legs thickness	2 mm
Plate thickness	2 mm
Capacity	600 kg
Drawer dimensions	433 x 347 x 122h mm
Drawer capacity	30 kg
Net weight	55 kg

**B022/10**

**WORKBENCH KIT**

With wood press top and a lockable drawer.



**UPGRADE**

Dimensions	1000 x 640 x 865h mm
Legs thickness	2 mm
Plate thickness	38 mm
Capacity	350 kg
Drawer dimensions	400 x 344 x 125h mm
Drawer capacity	50 kg
Net weight	47 kg

**B022/15**

**WORKBENCH KIT**

With wood press top and 2 lockable drawers.



**UPGRADE**

Dimensions	1500 x 640 x 865h mm
Legs thickness	2 mm
Plate thickness	38 mm
Capacity	350 kg
Drawer dimensions	400 x 344 x 125h mm
Drawer capacity	50 kg
Net weight	75 kg

**B017/C**

**DRAWER RACK WITH LOCK**

On ball bearing made of steel, suitable to benches of other brands.



Overall dimensions	680 x 270 x 130 mm
Internal dimensions	640 x 260 x 90 mm
Capacity	18,5 kg
Net weight	4,3 kg



**B009/A1**
**WORKBENCH KIT**

With wood press top, 3 lockable drawers, 1 shelf and adjustable feet.



Dimensions	1200 x 600 x 865h mm
Legs thickness	2 mm
Plate thickness	36 mm
Capacity	350 kg
Net weight	62 kg

**B009/B1**
**WORKBENCH KIT**

With wood press top, 3 lockable drawers, 1 shelf with door and adjustable feet.



Dimensions	1200 x 600 x 865h mm
Legs thickness	2 mm
Plate thickness	36 mm
Capacity	350 kg
Net weight	64,5 kg

**B009/A2**
**WORKBENCH KIT**

With wood press top, 3 lockable drawers, 1 door and shelf and adjustable feet



Dimensions	1690 x 600 x 865 mm
Legs thickness	2 mm
Plate thickness	36 mm
Capacity	350 kg
Net weight	84 kg

**B009/B2**
**WORKBENCH KIT**

With wood press top, 3 lockable drawers, 2 shelves with door and adjustable feet



Dimensions	1690 x 600 x 865 mm
Legs thickness	2 mm
Plate thickness	36 mm
Capacity	350 kg
Net weight	90 kg

**B019**
**FOLDABLE HEAVY DUTY WORKBENCH**

 Made of steel, tear down structure with 2 powerful gas struts, peg board 1195 x 458 x 20 mm, main leg height 1380 mm, total width for the product 1280 mm, depth of the open/close product 648/130 mm at a height of 330 mm, auto-lock with handle in the corner of top plate, peg board with holes  $\varnothing$  4 mm, distance between centers holes 25 mm for hooks with wire  $\varnothing$  3 mm.

Plate Dimensions	1195 x 648 x 41 mm
Slot distance	25 mm
Capacity	225 kg
Net weight	45 kg

**B019/G030**
**HOOK SET**

10 Pcs

Length	30 mm
Pins center distance	25 mm

**Gx**
**HOOKS SET**

10 Pcs

Art.	Pins center distance	Length
G050	30 mm	80 mm
G130	30 mm	155 mm







**P009**

**WALLCABINET KIT**

With 18 hooks included.

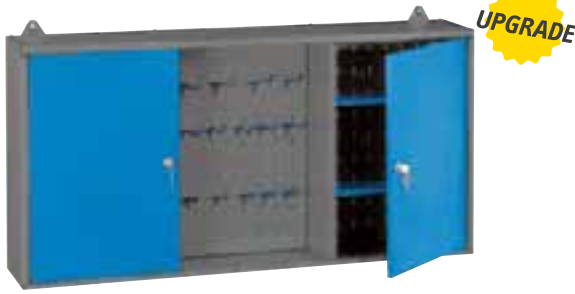

Cabinet dimensions	1200 x 200 x 600h mm
Steel thickness	0,8 mm
Internal shelves	4
Hooks	18 (6 + 6 + 6)
Slot distance	30 mm
Net weight	17 kg

**A100**

**CABINET**

With 1 drawer, slide on bearing with locking device.



Cabinet dimensions	500 x 460 x 1000h mm
Steel thickness	1 mm
Internal shelves	2
Maximum capacity	100 kg
Shelf capacity	25 kg
Net weight	35 kg

**A300**

**CABINET**

With 2 drawers, slide on ball bearing with locking device.



Cabinet dimensions	1000 x 460 x 1000h mm
Steel thickness	1 mm
Internal shelves	2
Maximum capacity	150 kg
Shelf capacity	25 kg
Net weight	62 kg

**C800**

**TOOL CABINET**

With 8 drawers, slide on bearing with locking device, without internal dividers.



Drawer capacity	50 kg
External Dimensions	630 x 550 x 930h mm
Drawer dimensions	517 x 440 mm
Drawers height	8 x 73 mm
Net weight	58 kg

**C600**

**TOOL CABINET**

With 6 drawers, slide on bearing with locking device, without internal dividers.



Drawer capacity	50 kg
External Dimensions	630 x 550 x 930h mm
Drawer dimensions	517 x 440 mm
Drawers height	6 x 115 mm
Net weight	53 kg

**C603**

**TOOL CABINET**

With 6 drawers, slide on bearing with locking device, without internal dividers.



Drawer capacity	50 kg
External Dimensions	630 x 550 x 930h mm
Drawer dimensions	517 x 440 mm
Drawers height	3 x 73 mm - 2 x 115 mm - 1 x 175 mm
Net weight	53,5 kg

**C800-**
**"A" DRAWER DIVIDERS**

Example dividers setting.



10 Pcs

Art.	Longitudinal divider	Transversal divider
C800/CC	440 x 70h mm	-
C800/LL	-	517 x 70h mm

**C600-**
**"B" DRAWER DIVIDERS**

Example dividers setting.



10 Pcs

Art.	Longitudinal divider	Transversal divider
C600/C	440 x 110h mm	-
C600/L	-	120 x 110h mm

**C603-**
**"C" DRAWER DIVIDERS**

Example dividers setting.



10 Pcs

Art.	Longitudinal divider	Transversal divider
C603/C	440 x 165h mm	-
C603/L	-	120 x 165h mm

**C080-**
**DRAWER UNITS WITH TRANSPARENT PULL-OUT DRAWERS**

Modular and stackable



Art.	External Dimensions	Drawer dimensions	Drawers number
C080/3	382 x 290 x 230h mm	372 x 285 x 73h mm	3
C080/6	382 x 290 x 230h mm	184 x 285 x 73h mm	6
C080/9	382 x 290 x 230h mm	122 x 285 x 73h mm	9

**C700**
**STEEL STORAGE CHEST WITH PLASTIC CASES**

Lower box with key lock and upper zone with 7 tool boxes with central lock 4 x C360 + 3 x C371.



Dimensions	490 x 343 x 987h mm
Net weight	27 kg

**C085-**
**DRAWER UNITS WITH TRANSPARENT PULL-OUT DRAWERS**

Modular and stackable.



Art.	External Dimensions	Drawer dimensions	Drawers number
C085/12	382 x 148 x 230h mm	122 x 145 x 55h mm	12
C085/16	382 x 148 x 230h mm	90 x 145 x 55h mm	16
C085/24	382 x 148 x 230h mm	59 x 145 x 55h mm	24



### C086/01C

#### MODULAR DRAWER UNIT WITH PULL-OUT DRAWERS

Connectable with other drawers through guides to create infinite combinations. Equipped with drawer locking to prevent the contents from accidentally falling and rear fixing holes for wall mounting. Made of resistant plastic, it is suitable for use in the construction site, at home and in the workshop.



Dimensions	295 x 165 x 200h mm
Drawers number	1
Drawer dimensions	250 x 150 x 150 mm



### C086/01T

#### MODULAR DRAWER UNIT WITH PULL-OUT TRAYS

Connectable with other drawers through guides to create infinite combinations. Equipped with trays locking to prevent the contents from accidentally falling and rear fixing holes for wall mounting. Made of resistant plastic, it is suitable for use in the construction site, at home and in the workshop.



Dimensions	295 x 165 x 200h mm
Drawers number	1
Drawer dimensions	250 x 160 x 150 mm

### C086/02C

#### MODULAR DRAWER UNIT WITH PULL-OUT DRAWERS

Connectable with other drawers through guides to create infinite combinations. Equipped with drawer locking to prevent the contents from accidentally falling and rear fixing holes for wall mounting. Made of resistant plastic, it is suitable for use in the construction site, at home and in the workshop.



Dimensions	295 x 165 x 200h mm
Drawers number	2
Drawer dimensions	250 x 160 x 70 mm

### C086/02T

#### MODULAR DRAWER UNIT WITH PULL-OUT TRAYS

Connectable with other drawers through guides to create infinite combinations. Equipped with trays locking to prevent the contents from accidentally falling and rear fixing holes for wall mounting. Made of resistant plastic, it is suitable for use in the construction site, at home and in the workshop.

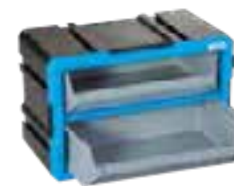

Dimensions	295 x 165 x 200h mm
Drawers number	2
Drawer dimensions	250 x 160 x 70 mm

### C086/04C

#### MODULAR DRAWER UNIT WITH PULL-OUT DRAWERS

Connectable with other drawers through guides to create infinite combinations. Equipped with drawer locking to prevent the contents from accidentally falling and rear fixing holes for wall mounting. Made of resistant plastic, it is suitable for use in the construction site, at home and in the workshop.



Dimensions	300 x 200 x 165 mm
Drawers number	4
Drawer dimensions	120 x 160 x 70 mm

### C086/04T

#### MODULAR DRAWER UNIT WITH PULL-OUT TRAYS

Connectable with other drawers through guides to create infinite combinations. Equipped with trays locking to prevent the contents from accidentally falling and rear fixing holes for wall mounting. Made of resistant plastic, it is suitable for use in the construction site, at home and in the workshop.



Dimensions	295 x 165 x 200h mm
Drawers number	4
Drawer dimensions	120 x 160 x 70 mm

### C086/12C

#### MODULAR DRAWER UNIT WITH PULL-OUT DRAWERS

Connectable with other drawers through guides to create infinite combinations. Equipped with drawer locking to prevent the contents from accidentally falling and rear fixing holes for wall mounting. Made of resistant plastic, it is suitable for use in the construction site, at home and in the workshop.



Dimensions	295 x 165 x 200h mm
Drawers number	12
Drawer dimensions	60 x 160 x 50 mm

### C086/04C/D

#### DIVIDER KIT FOR MODULAR DRAWER UNIT



Dimensions	111 x 63 mm
Pack	5



### C086/12C/D

#### DIVIDER KIT FOR MODULAR DRAWER UNIT



Dimensions	49.5 x 41 mm
Pack	5



**C090-**
**UNIVERSAL STORAGE BIN**

Modular and stackable.



Art.	Dimensions
C090/2	108 x 167 x 75h mm
C090/3	151 x 237 x 126h mm
C090/4	213 x 350 x 164h mm
C090/5	310 x 490 x 190h mm
C090/6	380 x 610 x 250h mm

**0849**
**ALUMINUM CASE SET**

Ergonomic handles and lock with key.

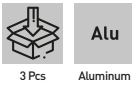

Cases dimensions	730 x 380 x 360h mm - 680 x 310 x 320h mm - 475 x 260 x 210h mm
Net weight	14 kg

**0382-**
**ALUMINUM CASE**

With key lock.



Art.	External Dimensions	Internal dimensions	Net weight
0382	760 x 335 x 250h mm, 1240 x 385 x 385h mm, 1445 x 520 x 460h mm	710 x 285 x 225h mm, 1185 x 335 x 365h mm, 1395 x 435 x 440h mm	40 kg
0382/02	760 x 335 x 250h mm	745 x 310 x 225h mm	6 kg
0382/03	1240 x 385 x 385h mm	1185 x 335 x 365h mm	14 kg
0382/04	1445 x 520 x 460h mm	1405 x 435 x 440h mm	21 kg

**C087**
**TOOL ROLLING CABINET**

Separable into 3 pieces.



Dimensions	560 x 350 x 770h mm
Capacity	40 kg
Net weight	14 kg

**0363-**
**3 PCS STEEL CASE SET**

Padlockable.



Art.	External Dimensions	Internal dimensions	Net weight
0363	770 x 420 x 305h mm, 915 x 440 x 565h mm, 1220 x 620 x 700h mm	750 x 400 x 300h mm, 825 x 350 x 410h mm, 1130 x 520 x 550h mm	107 kg
0363/30	770x420x305h mm	750 x 400 x 300h mm	14,5 kg
0363/36	915 x 440 x 565h mm	825 x 350 x 410h mm	35 kg
0363/48	1220 x 620 x 700h mm	1130 x 520 x 550h mm	57 kg





**C900/B**  
**TOOL ROLLING CABINET**

Side handle, polypropylene foam worktop, 6 drawers with internal oil-resistant mat, mounted on telescopic ball-bearing slides, front central locking supplied with 2 foldable keys, 2 fixed and 2 swivel casters with foot-operated brake, made of shockproof and non-slip thermoplastic rubber.

**UPGRADE**



**C900/A**  
**TOOL CHEST**

Can be combined with trolley carts. Retractable side handles, 6 drawers, mounted on telescopic ball-bearing slides, removable tray, and front central locking with 2 foldable keys.

**UPGRADE**



Dimensions	661 x 309 x 363h mm
Drawer dimensions	3: 174 x 267 x 45h mm   2: 578 x 267 x 45h mm   1: 578 x 267 x 60h mm
Compartment dimensions	655 x 250 x 80h mm
Drawer capacity	25 kg
Net weight	20 kg

Dimensions	744 x 461 x 964h mm
Drawer dimensions	569 x 406 mm
Drawers height	4 x 45 mm - 1 x 145 mm - 1 x 225 mm
Drawer capacity	25 kg
Net weight	44 kg



# DETAILS MAKE THE DIFFERENCE

We thought about meeting your needs. How? By taking care of the details and the choice of optionals, making the tool rolling cabinet your personal product to work easily and smoothly every day. So, the new FERVI rolling cabinets were born. Simple and easy to set up, thanks to the compliant list of accessories for all different models.

Set it up according to your needs. Our goal is to get you the tool rolling cabinet you dream, not just any rolling cabinet!

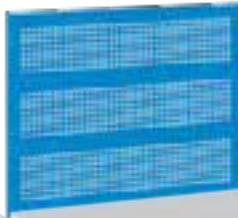
<b>C960/PF</b>	<b>NEW</b>
<b>PERFORATED HANGING PANEL</b>	
	
Dimensions	678 x 535 x 25h mm
Working table dimensions	678 x 535 mm
Hole diameter	Ø 5 mm
Slot distance	15 mm

<b>C960/PL</b>	<b>NEW</b>
<b>LAMINATED WORK TOP</b>	
	
Plate Dimensions	670 x 454 mm
Plate thickness	9 mm

<b>C960/MP</b>	<b>NEW</b>
<b>FOLDING SHELF</b>	
	
Dimensioni	338 x 261 x 35h mm
Steel thickness	1,50 mm



<b>C960/PC</b>	<b>NEW</b>
<b>PAPER ROLL HOLDER</b>	
	
Dimensions	386 x 167 mm
Hose diameter	15 mm
Max. roll diameter	280 mm

<b>C960/PD</b>	<b>NEW</b>
<b>DOCUMENT HOLDER</b>	
	
Internal dimensions	270 x 60 x 330h mm
Steel thickness	2 mm

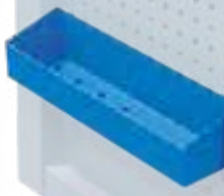
<b>C960/PG</b>	<b>NEW</b>
<b>SCREWDRIVER HOLDER</b>	
	
Dimensions	330 x 76 x 88h mm
Drawer dimensions	328 x 75 x 75h mm
Hole diameter	8 x Ø 8,5 mm



**C960/F6**

**TOOL ROLLING CABINET WITH 6 DRAWERS**

Side handle, polypropylene foam worktop, steel sheet body with impact protection bumpers and perforated side panels, 6 full-extension drawers with with oil-resistant mats, mounted on telescopic ball bearing slides, anti-tip device, side central locking supplied with 2 folding keys, 2 fixed and 2 swivel casters with brakes. Optional accessories: screwdriver holder, document holder, shelf, paper roll holder, rear pegboard and laminated top.

Dimensions	770 x 460 x 985h mm
Drawer dimensions	566 x 405 mm
Drawers height	4 x 68 mm - 1 x 147 mm - 1 x 199 mm
Drawer capacity	5 x 25 kg - 1 x 40 kg
Slot distance	15 mm
Hole diameter	Ø 5 mm
Net weight	55 kg



**C960/F7**

**TOOL ROLLING CABINET WITH 7 DRAWERS**

Side handle, polypropylene foam worktop, steel sheet body with impact protection bumpers and perforated side panels, 7 full-extension drawers with with oil-resistant mats, mounted on telescopic ball bearing slides, anti-tip device, front central locking supplied with 2 folding keys, 2 fixed and 2 swivel casters with brakes. Optional accessories: screwdriver holder, document holder, shelf, paper roll holder, rear pegboard and laminated top.

Dimensions	770 x 460 x 985h mm
Drawer dimensions	566 x 405 mm
Drawers height	6 x 68 mm - 1 x 199 mm
Drawer capacity	6 x 25 kg - 1 x 40 kg
Slot distance	15 mm
Hole diameter	Ø 5 mm
Net weight	58 kg



**C960/F8**

**TOOL ROLLING CABINET WITH 8 DRAWERS**

Side handle, polypropylene foam worktop, steel sheet body with impact protection bumpers and perforated side panels, 8 full-extension drawers with with oil-resistant mats, mounted on telescopic ball bearing slides, anti-tip device, front central locking supplied with 2 folding keys, 2 fixed and 2 swivel casters with brakes. Optional accessories: screwdriver holder, document holder, shelf, paper roll holder, rear pegboard and laminated top.

Dimensions	770 x 460 x 985h mm
Drawer dimensions	566 x 405 mm
Drawers height	7 x 68 mm - 1 x 120 mm
Drawer capacity	25 kg
Slot distance	15 mm
Hole diameter	Ø 5 mm
Net weight	60 kg



**C980**
**TOOL ROLLING CABINET**

7 drawers, with 2 side storage compartments, ball bearing equipped drawers with central lock, 12 hooks and 10 plastic bins included, 2 swivel and 2 fixed casters.



Drawer capacity	25 kg
Tool cabinet size	890 x 530 x 1030h mm
Drawer dimensions	565 x 405 mm
Drawers height	3 x 50 mm - 3 x 105 mm - 1 x 165 mm
Net weight	100 kg

**0466/4V**
**MAGNETIC TOOL TRAY SET**

Made of painted steel, to organize the best working place.

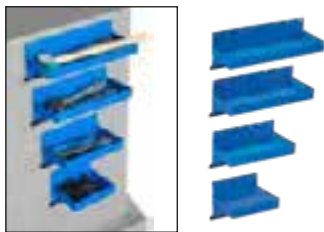

Overall dimensions	310 x 130 x 120h mm; 270 x 130 x 120h mm; 210 x 130 x 120h mm; 150 x 130 x 120h mm
Capacity	1,17 kg; 1 kg; 0,77 kg; 0,6 kg
Steel thickness	0,7 mm

**0466/PB**
**MAGNETIC SOCKETS HOLDER**

Made of painted steel, to organize the best working place.



Overall dimensions	280 x 45 x 90h mm
Sockets sizes	1/4" - 3/8" - 1/2"
Steel thickness	0,9 mm

**0466/CV**
**MAGNETIC HANGING TRAY WITH SCREWDRIVERS HOLDER**

Made of painted steel, to organize the best working place.

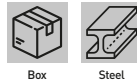

Dimensions	360 x 130 x 110h mm
Drawer dimensions	305 x 115 x 30h mm
Holes	6 x Ø 10 mm
Capacity	3,18 kg
Steel thickness	1 mm

**0466/SC**
**3 HOLE MAGNETIC SPRAY CANS AND 7 SCREWDRIVERS HOLDER**

Made of painted steel, to organize the best working place.



Overall dimensions	130 x 300 x 130h mm
Holes	3 x Ø 75 mm; 2 x Ø 12 mm; 1 x Ø 11 mm; 1 x Ø 10 mm; 1 x Ø 9 mm; 2 x Ø 7,5 mm
Capacity	1,19 kg
Steel thickness	0,8 mm



**0323/45**

**TOOL CHEST**

With 5 trays.



Steel



Dimensions  
Net weight

450 x 200 x 205 h mm  
4 kg

**0323/55**

**TOOL CHEST**

With 5 trays.



Steel



Dimensions  
Net weight

550 x 210 x 205h mm  
4,5 kg

**0423/1**

**TOOL BOX**

With 16 small and 4 middle plastic removable trays, ideal for storing small parts. Small plastic trays dimensions: 54 x 52 x 43h mm, middle plastic trays dimensions: 54 x 105 x 43h mm. The box has two safety locks to prevent the involuntary overthrow of the hardware.



Steel

Plastic



Dimensions

334 x 240 x 45 mm

**0423/2**

**TOOL BOX**

With 29 small and 3 middle removable plastic trays, ideal for storing small parts. Small plastic trays dimensions: 54 x 52 x 43h mm, middle plastic trays dimensions: 54 x 105 x 43h mm. The box has a central safety lock to prevent the overthrow of the hardware.



Steel

Plastic



Dimensions

388 x 295 x 45 mm

**0422-**

**POLYPROPYLENE BLISTER SET**

Useful for storing small items such as screws, bolts, nuts, small hooks, nails



20 Pcs

Plastic



Art.

Dimensions

0422/B1  
0422/B3

65 x 47 x 30 mm  
75 x 60 x 40 mm

**C315**

**TOOL ORGANIZER BOX**

With 21 compartments and movable dividers, for storing larger items than the original magazine.

Plastic



Dimensions

380 x 310 x 60 mm

**C313**

**RACK WITH 4 PLASTIC TOOL ORGANIZER BOXES**

Modular, with 13 extractable containers of various sizes, equipped with lateral insets for stacking and rear holes for wall fixing.

Plastic



Dimensions

377 x 265 x 310 mm

**C360**

**TOOL BOX**

With 23 compartments and 16 removable dividers.



Box

Plastic



made in Italy



Dimensions

443 x 317 x 80h mm



**C371**
**TOOL BOX**

With removable 2 big trays, 3 medium trays, 6 small trays.



Dimensions 443 x 317 x 107h mm

**C163**
**TOOL-BOX**

16", lockable, with 1 movable shelf and 2 compartments for motion work in the lid.



Dimensions 394 x 160 x 195h mm

**C165**
**TOOL-BOX**

20", with 1 movable shelf and 2 compartments for motion work in the lid.



Dimensions 514 x 225 x 260h mm

**C648**
**TOOL BOX**

With movable shelf.



Dimensions 510 x 280 x 220h mm

**M13x**
**WATERPROOF TOOL CASE**

Built in pressure valve with cubed-foam interior to protect the objet stored. it is ideal for instruments and test equipment.



Art.	External Dimensions	Internal dimensions	Net weight
M138	465 x 360 x 175h mm	425 x 287 x 115h mm	2,9 kg
M139	570 x 410 x 215h mm	505 x 353 x 140h mm	4,5 kg

**M138**

**M139**

**M300/B**
**WATERPROOF TOOL CASE**

Built in pressure valve with cubed-foam interior to protect the objet stored. The superior protection from the elements, water, dust and impacts, make it suitable for a wide array of sectors and applicazions.

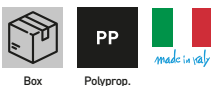

External Dimensions	336 x 300 x 148 mm	Working temperature	-30 / 90°C (-22 / 194°F)
Internal dimensions	300 x 225 x 132 mm	Net weight	1,6 kg
Internal volume	8.91 l		

**M430/B**
**WATERPROOF TOOL CASE**

Built in pressure valve with cubed-foam interior to protect the objet stored. The superior protection from the elements, water, dust and impacts, make it suitable for a wide array of sectors and applicazions.

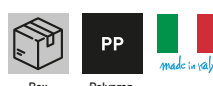

External Dimensions	464 x 366 x 176 mm	Working temperature	-30 / 90°C (-22 / 194°F)
Internal dimensions	426 x 290 x 159 mm	Net weight	2,8 kg
Internal volume	19.64 l		





### M505/B

#### WATERPROOF TOOL CASE

Built in pressure valve with cubed-foam interior to protect the objet stored. The superior protection from the elements, water , dust and impacts, make it suitable for a wide array of sectors and applications.



Box



PP



made in Italy

External Dimensions	555 x 428 x 211 mm
Internal dimensions	500 x 350 x 194 mm
Internal volume	33.95 l
Working temperature	-30 / 90°C (-22 / 194°F)
Net weight	3,9 kg

### M540/BT

#### WATERPROOF TOOL CASE WITH TROLLEY

Built in pressure valve with cubed-foam interior to protect the objet stored. The superior protection from the elements, water , dust and impacts, make it suitable for a wide array of sectors and applications.



Box



PP



made in Italy

External Dimensions	594 x 473 x 270 mm
Internal dimensions	538 x 405 x 245 mm
Internal volume	53.38 l
Working temperature	-30 / 90°C (-22 / 194°F)
Net weight	5,2 kg

### 0682

#### ABS TOOL CASE

Tools not included.



Box



ABS

A	460 mm
B	330 mm
C	150 mm
D	98 mm
E	52 mm
Capacity	25 kg
Net weight	2,9 kg

### 0683

#### TROLLEY ABS TOOL CASE

Tools not included.



Box



ABS

A	460 mm
B	330 mm
C	190 mm
D	98 mm
E	92 mm
Capacity	25 kg
Net weight	4,5 kg

### 068x

#### ALUMINIUM TOOL CASE

Tools not included.

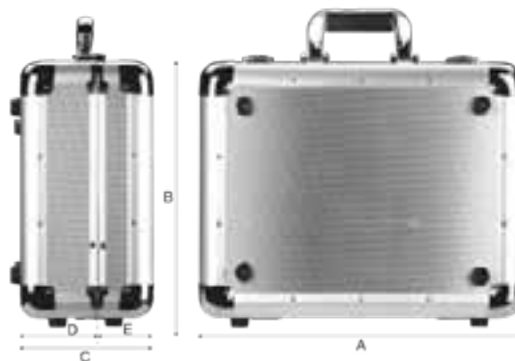

Art.	A	B	C	D	E	Capacity	Net weight
0680	510 mm	375 mm	185 mm	110 mm	75 mm	30 kg	5 kg
0681	440 mm	390 mm	185 mm	110 mm	75 mm	30 kg	4,8 kg



**0901**

**NEW**

**MULTIFUNCTIONAL BACKPACK**

Made of 600-denier polyester, with breathable back, removable tool holder, padded computer pocket, roomy and sturdy pockets to accommodate a large number of tools.



Polyester

External Dimensions

380 x 130 x 460 mm

Net weight

1,25 kg

**0907**

**NEW**

**SEMI-SOFT TOOL TROLLEY**

Tool trolley made of 600-denier polyester, sturdy telescoping handle for excellent handling, convenient front strap opening, multiple roomy and sturdy pockets.



Polyester

Dimensions

390 x 290 x 390 mm

Net weight

3,1 Kg

**0902**

**NEW**

**SOFT TOOL BAG**

Made of 600-denier polyester, with comfortable shoulder strap, roomy and sturdy pockets to accommodate a large number of tools.



Polyester

Dimensions

370 x 203 x 254 mm

Net weight

1,25 Kg

**0903**

**NEW**

**SOFT TOOL BAG**

Made of 600-denier polyester, with comfortable shoulder strap, roomy and sturdy pockets to accommodate a large number of tools.



Polyester

Dimensions

450 x 280 x 220 mm

Net weight

2,05 Kg

**0904**

**NEW**

**SEMI-SOFT TOOL BAG**

Made of 600-denier polyester, with rigid handle for easy handling, comfortable shoulder strap, capacious and sturdy pockets.



Polyester

Dimensions

406 x 203x 254 mm

Net weight

1,3 Kg



0905

NEW

**SEMI-SOFT TOOL BAG**

Made of 600-denier polyester, with rigid handle for easy handling, comfortable shoulder strap, capacious and sturdy pockets.



Polyester

Dimensions 450 x 228 x 280 mm  
Net weight 2,3 Kg

0906

NEW

**SEMI-SOFT TOOL BAG**

Made of 600-denier polyester, with rigid handle for easy handling, comfortable shoulder strap, capacious and sturdy pockets.



Polyester

Dimensions 450 x 228 x 330 mm  
Net weight 1,6 Kg

0390

**TOOL BAG**

With shoulder belt made of 1680 denier polyester, big and rugged pockets to accommodate a great number of tools



Polyester

Pockets 14  
Dimensions 400 x 225 x 250h mm

0409

**TOOL BAG**

10 pockets with belt, made of polyester. It can be used to hold small tester, pliers, scissors, screwdrivers and other tools.



Polyester

Dimensions 250 x 210 x 70 mm

0254

**FITTER TOOL BAG**

Leather with belt.



Pockets 5

0264

**FITTER TOOL BAG**

Leather with belt.



Pockets 11